

ANALYSIS of PID CONTROL SYSTEM USING EXPERIMENT SET for UNDERGRADUATE ENGINEERING STUDENTS

***Ozgur Mercanli¹, Hilmi Kuscu¹**

¹ *Trakya University, Department of Mechanical Engineering*

Trakya University Engineering Faculty, Edirne/TURKEY

(E mail:ozgurmercanli@trakya.edu.tr)

Abstract

PID controllers are the most used controllers. Theoretical understanding of the system to be controlled and its working principles are very important for closed-loop control. This basic knowledge is learned in principle by all undergraduate engineering students. However, understanding the practical aspects of a PID controller implementation must be cleverly combined with their links to theoretical concepts. This article examines the theoretical and practical training development process with the PID experiment set, showing a setup that can serve as a bridge between the theoretical and practical worlds of control system knowledge. By changing the coefficients of K_p , T_i , and T_d , students will observe the change between the input and output signals of the control system, so they will be able to make visual and theoretical analyses on the oscilloscope screen.

Keywords: PID controller, Experiment set, closed-loop systems, educational aspect, PID experiment

1. INTRODUCTION

PID controllers are the most commonly used controllers. [1] Theoretical understanding of the system to be controlled and its working principles are very important for closed-loop control. [2] This basic knowledge is learned in principle by all undergraduate engineering students.

However, understanding the practical aspects of a PID controller implementation must be cleverly combined with their links to theoretical concepts. The most important component of an ideal PID control, $e(t)$, is the control error, which is a value of the basic undergraduate course in Automatic Control Systems. The effects of proportional, integral, and derivative actions are included in the course content in a simple and understandable way, based on numerical simulation results. [3] Then, automatic control lessons are taught by focusing on the block diagrams of the feedback control system, the Laplace domain and time domain basic equations, the transient and steady-state error, the steady state, and the effect of integral and derivative motion on the

closed loop system. The whole system is also included in the application of the Ultimate Value Theorem and the concept of system type. The dynamic properties of feedback control systems with ideal PID controllers can be easily evaluated theoretically and mathematically with Bode diagrams. Finally, the lessons are completed by evaluating the methods of several PI and PID setting rules that are widely used in practice. [6]

Although the content of the course is enriched with theoretical and mathematical applications, in order to better understand the basis of automatic control systems, it should be reinforced and become more understandable by observing the results experimentally in the laboratory environment with the students.

The content of this paper is organized as follows. In section 2, the components required to develop the physical demonstration setup are introduced as proposed PID, and experimental materials and devices are illustrated. In section 3, several recommended

experiments are included. In addition, detailed information is given on some of our observations and feedback from our students. Finally, the paper is concluded in section 4.

2. MATERIALS&METHOD

2.1 Proportional Control

The reason why on-off control often gives rise to oscillations is that the system overreacts because a small change in the error will make the manipulated variable change over the full range. This effect is avoided in proportional control where the characteristic of the controller is proportional to the control error for small errors.

2.2 Integral Action

The main function of the integral action is to make sure that the process output agrees with the setpoint in a steady state. With proportional control, there is normally a control error in the steady state. With integral action, a small positive error will always lead to an increased control signal, and a negative error will give a decreasing control signal no matter how small the error is. The following simple argument shows that the steady-state error will always be zero with integral action.

2.3 Derivative Action

The purpose of the derivative action is to improve closed-loop stability. The instability mechanism can be described intuitively as follows. Because of the process dynamics, it will take some time before a change in the control variable is noticeable in the process output. Thus, the control system will be late in correcting for an error. The action of a controller with proportional and derivative action may be interpreted as if the control is made proportional to the predicted process output, where the prediction is made by extrapolating the error by the tangent to the error curve.

The PID controller has three terms. The proportional term P corresponds to proportional control. The integral term I give a control action that is proportional to the time

integral of the error. This ensures that the steady-state error becomes zero. The derivative term D is proportional to the time derivative of the control error. This term allows for the prediction of future errors. There are many variations of the basic PID algorithm that will substantially improve its performance and operability. [1][4]

PID control system diagrams,block diagrams and tranfer funstions shown in Fig.1, Fig.2 and Fig3 respectively.

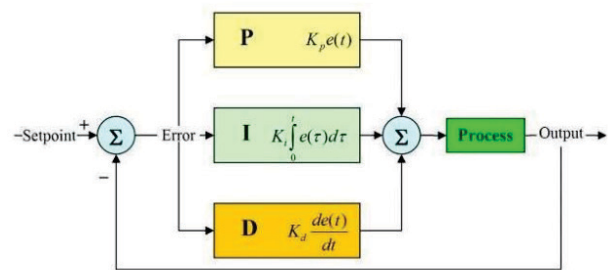

Fig.1.1 PID Control System [5]

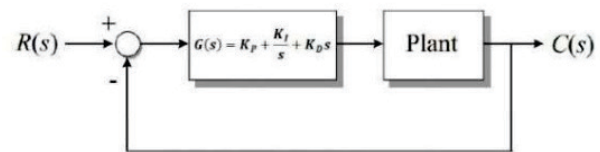

Fig.2. PID Control Block Diagram[5]

$$G(s) = K_p + \frac{K_i}{s} + K_d s$$

Fig.3. PID Control Transfer Functon[5]

2.4 Using Oscilloscope in PID experiment

An oscilloscope is a measuring device that allows us to see time-dependent changes in electrical voltage. We know that a voltmeter is used to measure electrical voltage under normal conditions. Voltmeters show us only the magnitude and direction of the voltage in the circuit displayed numerically on its screen. The oscilloscope, on the other hand, presents the variation of the voltage with time as a two-axis graph in an easier-to-understand. We can measure the voltage and frequency values digitally, as well as using the voltage and frequency reference values adjusted on the scaled oscilloscope screen. We measure the frequency value in the x-axis (horizontal) direction and the voltage amplitude and value in the y-axis (vertical) direction.

In addition, frequency and voltage behavior patterns can be monitored graphically on the oscilloscope screen as output value according to the input value.

In this experiment, we use a Digital storage oscilloscope GW-Instek GDS 1102A-U[8] as shown in Figure 4.

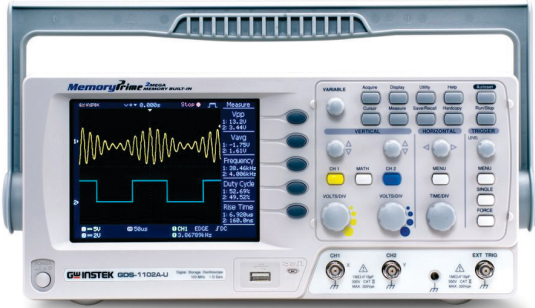

Fig.4. GW-Instek GDS 1102A-U oscilloscope [8]

2.5 Experimental Set

There are different possibilities for the structure of the PID controller, as for all other combinations. This type which shown fig.4 is particularly graphic; namely the parallel circuit three decoupled signal controller, whose output voltages are then added. Due to the parallel circuit, each controller can operate independently to others. Practical controllers are usually assembled with one or more operational amplifiers, whereby the PID behaviors is released by suitable feedback.

The influence of three components can usually be set externally;

- The **P** part proportional sensitivity K_p
- The **I** part by the integral action time T_n
- The **D** part by the derivative action time T_d

The D part, therefore, ensures that the controller reacts quickly even in the case of slow changes at its input. The P part takes care of medium amplifications and the I part causes the controller to operate accurately without leaving a control difference. Deriving the individual controller parameters from the jump reply or rise reply is difficult since the three components overlap. In this experiment, we, therefore, concentrate on comparative observation. HPS SystemTechnik [7] PID board illustrated in Figure 5.

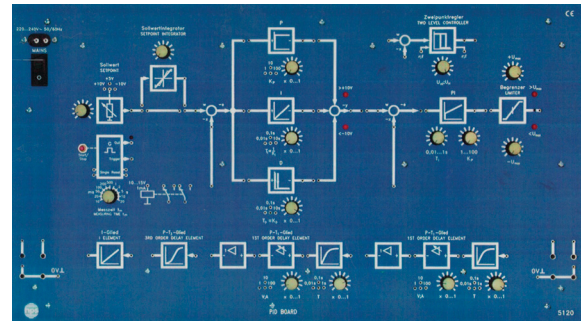

Fig.5. HPS System Technik PID Board V 5120[7]

The set point generator allows set point jumps to be set in the range of $-10V \dots +10V$ and fed directly or through the set point integrator to the measuring object.

3. RESULTS AND DISCUSSION

By changing the coefficients of K_p , T_i , and T_d , students will observe the change between the input and output signals of the control system, so they will be able to make visual and theoretical analyses on the oscilloscope screen.

Students set the experiment circuit shown in fig 6 and select the following setting which is illustrated in Table 1 for the measurement. Each column refers to different measurements which written on Table1 respectively

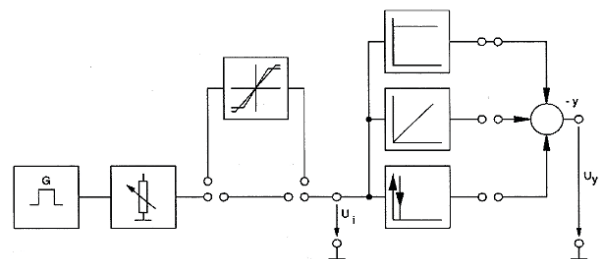

Fig.6. Experimental circuit.

Each column refers to different measurements which written on Table1 respectively.

To measure the jump reply we apply the pulse voltage directly to the set point potentiometer.

Table.1. Experiment settings and parameters

Measurement No	Jump Reply		
	1	2	3
Controller	P	PI	PID
Measuring Cycle T_m	10ms		
Set Point Integrator			
Jump U_i	1 V		
Proportional Action Factor K_p	2	3	5
Integration Time T_i	0,1sn		
Differential Action Time T_d	0,1sn		

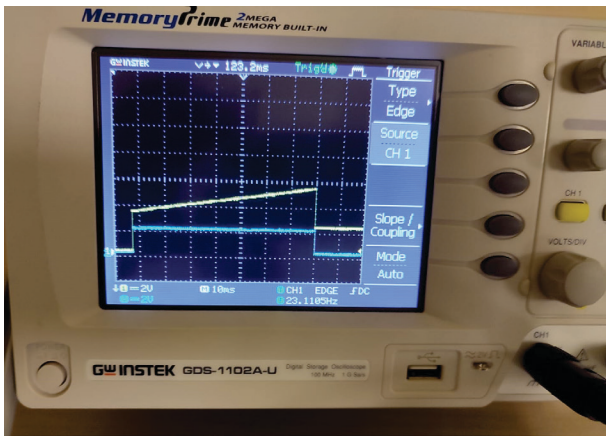

Fig.7. PI output on the oscilloscope display

The jump response of the PID experiment according to table 1 column 2 on the Oscilloscope screen is shown in Figure 7. From Chanel 2 we applied input signal blue colored square waveform. And from channell we got the output signal yellow colored which referred to the behavior of the PI behavior.

The monitoring of the jump response of the PID experiment according to table 1 column 3 on the oscilloscope screen and the connection of the experiment set with the oscilloscope is shown in figure 8. Yellow colored is the output signal and referred the behavior of the PID controller.

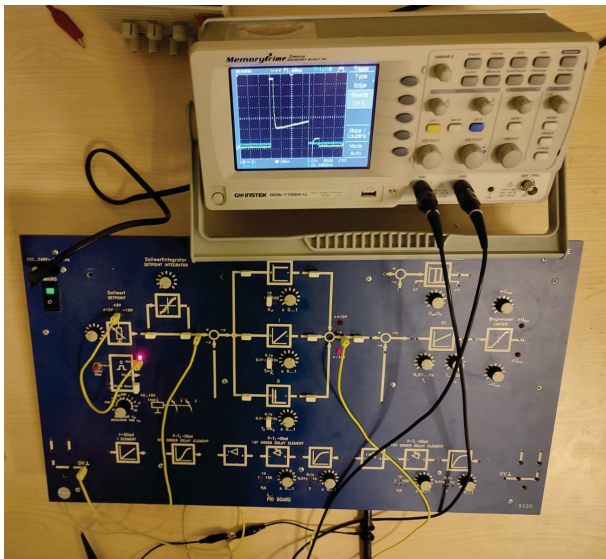
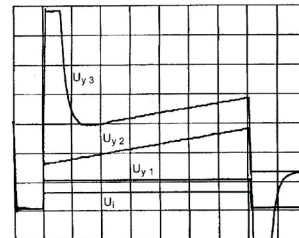

Fig.8. PID output on oscilloscope display

Figure 9 shows the results of all three experiments observed and measured on the oscilloscope screen and transferred to the scaled paper according to the reference values given. The results of P, PI and PID denier are included in this paper.

Each of the three controllers (P, I, and D) is limited by a peak limiter that keeps the output signal 10,5 V (+/- 1V). After summation of the three parts, however, voltages may appear, which are greater than 10.5 V. This mainly depends on the adjustment of the proportional action factor K_p .



Measurement no. 1, 2 and 3
 Jump reply:
 manipulated variable U_{y3} : 2 V/div
 manipulated variable U_{y2} : 2 V/div
 manipulated variable U_{y1} : 2 V/div
 control difference U_i : 2 V/div
 t: 1 ms/div

Fig.9. Experimental results

Students can able draw the output diagrams on scaled paper. So they see the difference between both three different experiments, and visually they can compare and analyze the behaviors of the components. They can describe the jump reply PID controller and compare it with that of the PI controller. They can shade the derivative action area in the jump of the PID controller and measure the T_d .

4. CONCLUSIONS

The presented results can be used as part of a complex control system, helping to gain and analyze basic design information to make the transition to advanced control issues devoted to PI/PID controller design.

During the calibration and both manual tuning, the students encounter different practical challenges where they can associate those problems with the theoretical lectures where various aspects are assumed ideal.

REFERENCES

- [1] Aström K.J., Haggland T., PID Controllers 2nd Edition Instrument Society of America 1995.
- [2] Csurcsia P., Z., Bhandari P., Troyer T.D., Development of a low-cost PID setup for engineering technology students IFAC Papers OnLine 55-4 (2022) 213–218
- [3] Yurkovich V.D., Naidu S.D., Educational Issues of PI-PID Controllers 9th IFAC

- Symposium Advances in Control Engineering
The International Federation of Automatic
Control Nizhy Novgorod, Russia, June 19-
21,2012 DOI:10.3182/2010619-3-ru-202400090
- [4] Ozdas N.M., Dinibütün T.A., Kuzucu A.,
Otomatik Kontrol Temelleri 2nd Edition Birsen
İstanbul 1998
- [5] Kuscı H., Automatic Control Lecture Notes
- [6] Ziegler N.J., Nichols N.B., Optimum Settings
for Automatic Controllers *J. Dyn. Sys., Meas.,
Control.* Jun 1993, 115(2B): 220-222 (3 pages)
<https://doi.org/10.1115/1.2899060>
- [7] Systemtechnik <https://www.systemtechnik-online.de/home/>
- [8] GW-Instek <https://www.gwinstek.com/en-global>.