

## PROBLEMS IN DESIGNING PIEZOELECTRIC COMPRESSION HARVESTERS

**Rumyana Stoyanova**  
*TU – Gabrovo*

**Dimo Kolev**  
*TU – Gabrovo*

**Velimira Todorova**  
*TU – Gabrovo*

### Abstract

*The aim of the presented research is to develop piezoelectric energy harvester which utilizes cheap, affordable piezoelectric elements and scavenges the mechanical energy from the traversing pedestrians. Initial research was also carried out to evaluate the applicability and possible path for the development of such kind of devices as well as the factors that define the volume for the obtainable energy for the current design.*

**Keywords:** compression; energy harvesting; piezoelectric.

### INTRODUCTION

In the last decade the Energy Harvesting (Power Harvesting or Energy Scavenging) has increasingly been the object of research and development. EH processes provide a limited quantity of electric supply for electronic devices with low consumption as the energy is extracted from background phenomena which have no direct significance for a given system or are parasitic in their nature. Prime examples of this kind of phenomena are the temperature gradient and vibrations created in the working process of the internal combustion engine and the presence of a huge volume of electromagnetic radiation in the city environment due to radio or television broadcasting and mobile communications.

### EXPOSITION

#### *A. Piezoelectric energy harvesters*

When creating harvester system, what should be considered is not only the output power volume that will be obtained but also the conversion mechanism which will be utilized. For harvesting mechanical stresses and exertions the piezoelectric harvesters are highly suitable [1-3] because of the very high ratio of conversion distinctive for the piezoelectric materials. Some piezoelectric harvesters are designed for collecting the waste energy of human motion as they are

mounted in part of the human clothing – for example, vibrational harvesters are mounted in the shoe soles. Other types are stationary mounted in appropriate locations so that passing vehicles [1-4] or pedestrians exert mechanical force over them. Stationary harvesters are developed in connection with the concepts for smart cities and are actively researched.

Piezoelectric harvesters can be of several types – namely, pure vibrational harvesters, compression ones and mixture of both types. Compression and vibrational piezoelectric harvesters work on the same principles (direct and reverse piezoelectric effects) and the difference between them actually is in the operational mode. Vibrational harvesters are supposed to be impacted by external mechanical forces and stresses that have pure harmonic nature or their description can be done with relatively adequate precision by sine and cosine functions, i.e. they can be considered to function in a purely dynamical mode. Compression piezoelectric harvesters operate in the static mode or under forces that can be described as relatively static over prolonged time periods.

The external mechanical force deforms the piezoelectric material in the compression harvester, thus generating electrical charge in the form of a single energy spike, while a (dynamical) deformation in the vibrational

harvester creates multiple fading vibrational oscillations that have multiple energy peaks (Fig. 1).

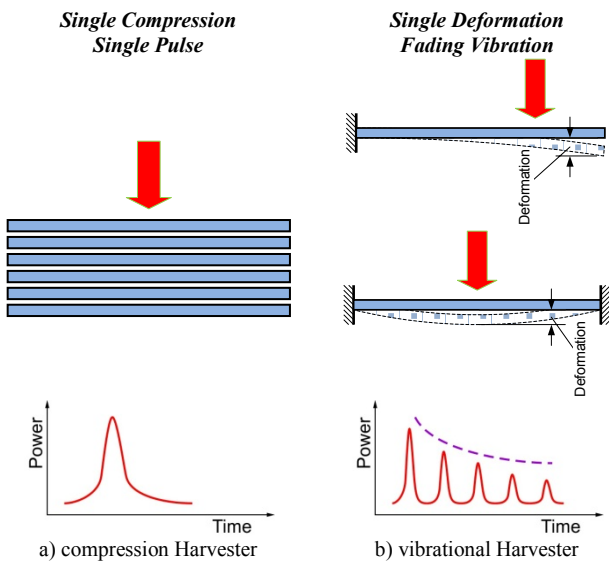
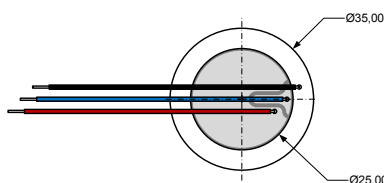

**Fig. 1.** Difference between compression and vibrational harvester

There is no guarantee with compression harvesters that the impacting mechanical forces will have exclusively static characteristics. Thus in this type of harvesters, mechanical force is determined to a large extent by various random factors [4], which further complicate the development of a common model. In practice for the compression harvesters experimentally-oriented approaches for evaluating the possible obtainable energy are used as they are highly dependent on specific harvester manufacturers [1].

**B. Design of Compression Harvester**

The developed compression harvester is supposed to be mounted as a flooring part on which passing of multiple pedestrians is done with the aim to harvest electrical energy from the human transition [4].



**Fig. 2.** The chosen piezoelectric resonator

As primary transducers in the compression harvester, standard piezoelectric resonators are

chosen with resonance frequency of 2,9 kHz ( $\pm 500$  Hz), thickness of 300  $\mu$ m and diameter of 25 mm (Fig. 2) [5] because of their accessibility and relatively low price. The resonators have metal base with diameter of 35 mm which is being treated as common electrode (black color electrode on Fig. 2).

Flat, rectangular section of dielectric fabric is chosen with the dimensions of 840x510 mm and thickness of 7 mm for the harvester base, on which the piezoelectric resonators as well as the protective cover from same material will be mounted.

The constructive problem in this type of harvester is the effective distribution of the active elements in the selected harvester area which will guarantee that the maximum possible amount of electrical energy is collected with the minimum number of elements.

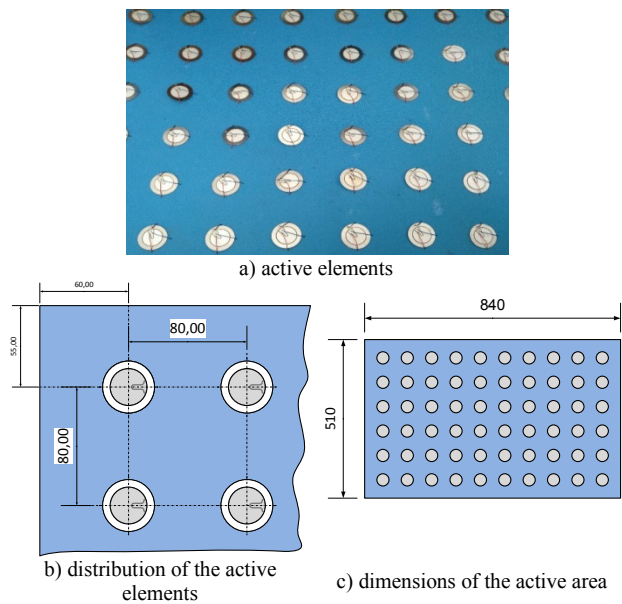

**Fig. 3.** Active area of the compression harvester

For the initial research a preliminary square distribution of the active elements is chosen (Fig. 3,b) as every element is located on 80 mm apart from its neighbors. With the chosen base dimensions, sixty active elements are distributed over the base and they are covered by another layer of the dielectric material.

The next problem in constructing an compression piezoelectric harvester is the wiring of the individual elements as the serial connection is supposed to increase the

magnitude of the obtained signal and the parallel connection is to result in increasing the current density of the harvester. After preliminary connection testing, the established conclusion is that when the serial element connection is used the output power is obtained only when every connected element in given line is simultaneously compressed because when one of them is not pressed then the circuit is actually open one. Because of this, the electrical wiring is chosen to be from the parallel type which will guarantee the undisturbed operations for the all active harvester elements as is shown on Fig. 4.

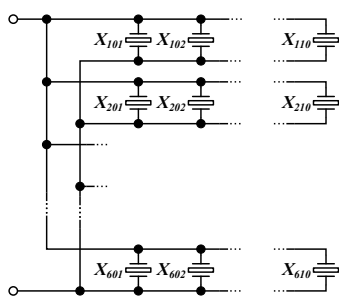

Fig. 4. Electrical wiring of the active elements

### C. Preliminary (“Static”) Experiments

Experiments are done only for the active part of the compression harvester as for the interface circuit is used simplified version of the energy collecting system which actually consists of full rectifier bridge, condenser in the role of energy storage and load resistance with chosen value for calculating the obtained electrical power. Electrical circuit is given on Fig. 5 as parallel to the load measurement voltmeter can be connected.

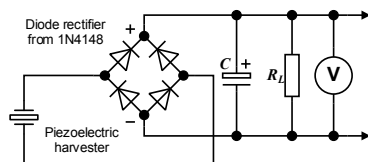

Fig. 5. Simplified testing interface

The capacitance for the condenser is chosen to be with standard value of  $1 \mu F$  and the load resistance is chosen to be  $1 M\Omega$  due to the fact that piezoelectric elements have low current density.

The experiments are carried out with connected digital measurement unit DT9201A as voltmeter in parallel (Fig. 5) and these are

designated as “static” because the only maximal amplitude of the signal is monitored for given time. In the initial experiments a group of volunteers is initially interviewed for determining their shoe size, then they are weighed by digital scales SWG180A1 (Silver Crest®). The volunteers are asked from one and the same standing position to board the pad by placing both feet one next to each other and then to descent from it for given time. Each participant is asked to repeat the procedure ten times as maximum voltage value is taken into account for every iteration;

Obtained voltage results for each participant as well as its mass and shoe size are given in Table 1. Data from the conducted experiments shows a large dispersion of the obtained values, which indicates that the processes in the harvester should be considered not purely static but have a definite dynamic component that has not been counted in these initial experiments.

TABLE 1. “STATIC” EXPERIMENTAL RESULTS

Shoe size	Mass, kg	1	2	3	4	5	6	7	8	9	10	Average	Power, $\mu W$
45	96,5	0,3	0,51	0,38	0,61	0,47	0,58	0,75	0,37	0,43	0,49	0,489	0,239121
42	90,2	0,26	0,65	1	0,91	0,84	0,69	0,34	0,54	0,8	0,6	0,663	0,439569
37,5	75,7	1	0,65	0,27	0,35	0,49	1,03	0,64	0,61	0,3	0,64	0,598	0,357604
37	66,7	0,92	0,76	0,34	0,27	0,51	0,83	0,21	0,49	0,52	0,43	0,528	0,278784
43	90,5	0,46	0,52	0,7	0,85	0,4	0,43	0,69	0,39	1,02	0,41	0,587	0,344569
45	80,5	0,77	0,34	0,2	0,45	0,47	0,42	0,81	0,22	0,45	0,6	0,473	0,223729
45	96	0,22	0,66	0,81	0,41	0,54	0,34	0,78	0,34	0,31	0,53	0,494	0,244036
42	100,2	0,48	0,54	0,36	0,14	0,47	0,13	0,22	0,29	0,62	0,24	0,349	0,121801
37	65	0,04	0,2	0,87	0,03	0,06	0,24	0,9	0,27	0,05	0,35	0,301	0,090601
39	72	0,55	0,45	0,18	0,16	0,65	0,06	0,26	0,27	0,11	0,4	0,309	0,095481
<b>Total</b>												<b>0,4791</b>	<b>0,24353</b>

### D. Experiments with Dynamic Component

Measurement DAQ board USB-6001 (NI) is used for monitoring the dynamic component of the harvester signal (Fig. 6).

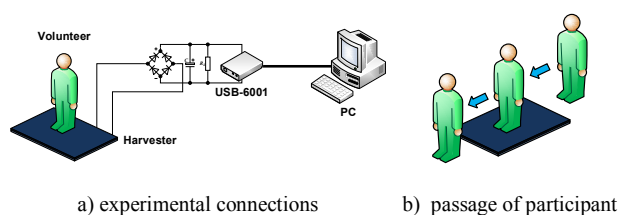

Fig. 6. Experimental set with DAQ board

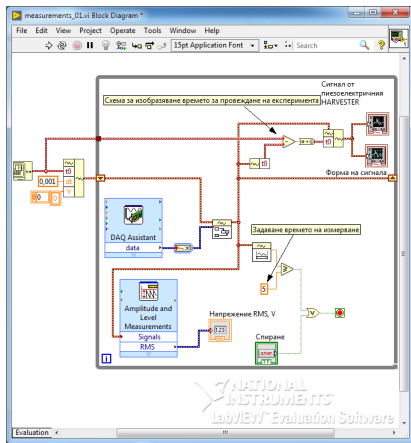

Fig. 7. Application provision for the experiments

For this task in program environment LabView® a block-diagram (Fig. 7) controlling the data obtaining process is designed which uses “while” cycle for measurements as this action will be executed at least once. The measurements are being repeated until the preset time is over or the command for stoppage is not selected. All of the obtained results for the voltages are displayed in RMS form for increased clarity and the measurement time period is set to be 5 s. The measurement procedures are the same as with the preliminary experiments but the participants pass over the active part of the harvester in one direction in time (as shown on Fig. 6,b).

Mass, kg		Shoe Size	
98		45	
Measurement	U <sub>RMS</sub> , V for 5 s	U <sub>RMS</sub> , V for 1 s	Energy, W/s
1	0.868691	0.1737382	3.0185E-08
2	1.4554	0.29108	8.47276E-08
3	1.2826	0.25652	6.58025E-08
4	1.02731	0.205462	4.22146E-08
5	1.07012	0.214024	4.58063E-08
6	1.20689	0.241378	5.82633E-08
7	1.52894	0.305788	9.35063E-08
8	1.03778	0.207556	4.30795E-08
9	0.691448	0.1382896	1.9124E-08
10	0.71072	0.142144	2.02049E-08
<b>Average</b>	<b>1.0879899</b>	<b>0.21759798</b>	<b>5.02914E-08</b>
Mass, kg		Shoe Size	
90		43	
Measurement	U <sub>RMS</sub> , V for 5 s	U <sub>RMS</sub> , V for 1 s	Energy, W/s
1	0.792981	0.1585962	2.51528E-08
2	0.576948	0.1153896	1.33148E-08
3	1.10898	0.221796	4.91935E-08
4	1.43602	0.287204	8.24861E-08
5	0.768947	0.1537894	2.36512E-08
6	0.999946	0.1999892	3.99957E-08
7	1.78872	0.357744	1.27981E-07
8	1.38203	0.276406	7.64003E-08
9	0.958657	0.1917314	3.67609E-08
10	1.33549	0.267098	7.13413E-08
<b>Average</b>	<b>1.1148719</b>	<b>0.22297438</b>	<b>5.46277E-08</b>

a) data for Participant 1      b) data for Participant 4

Fig. 8. Experimental data for two participants

The average quantity energy obtained for four participants passing the active part of the energy harvester is displayed in Table 2.

TABLE 2. DATA FOR “DYNAMIC” EXPERIMENTS

Parameter	Participant 1	Participant 2	Participant 3	Participant 4
Mass, kg	90	64,5	76	98
Shoe Size	43	37/38	36/37	45
Average Energy, W/s	5,4628.10 <sup>-08</sup>	2,4317.10 <sup>-08</sup>	2,7723.10 <sup>-08</sup>	5,0291.10 <sup>-08</sup>

It is interesting to compare the readings for the different participants that pass through the harvester which demonstrate different “signatures” of their gait (Fig. 9).

The obtained energy curves for the different participants are defined by the stepping force and the acceleration with which every participant pass through the active surface of the harvester. The participants are doing two steps on the dielectric mat averagely which is illustrated by the curves for three different passings of the volunteers (Fig. 9).

It is evident that every passing has own unique features but the passing patterns for a specific participant have similarities which are predefined by the inherent height, weight, the shoe size, the gait amplitude, the speed of passing, etc.

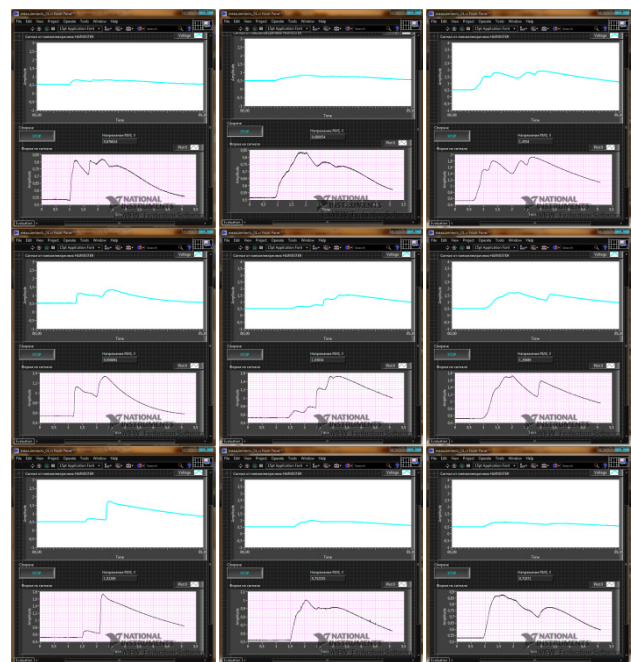

Fig. 9. Comparison between the participants

### E. Evaluation for the developed harvester

The developed piezoelectric compression harvester in principle can obtain energy from the passing through pedestrians but the energy quantity is impractical for powering any of presently existing low consumption devices. Also the experiments reveal that there is high

degree of randomness in acquiring the energy from pedestrians as this is connected with the mechanism of human gait and motions. Factors that have influence over energy acquisition in the current case are the size of the foot; the gait pattern; the weight of the pedestrian; exerted force per unit area; speed of passing; biological sex and age of the pedestrians; the used footwear; the expected numbers of the traffic. All of the listed factors are highly random in their nature, except for the traffic numbers as the harvester can be put in locations with highly concentrated traffic (for example building entrances, hallways, etc.) which can guarantee in some degree a relatively stable energy flux.

## CONCLUSION

The currently chosen distribution pattern for the active piezoelectric elements is not optimal as there are “blind” spots in the active area that are not used efficiently. The chosen transducers are not sufficiently effective in transforming the mechanical energy, i.e. there is a need for specialized (more expensive) piezoelectric elements. The device currently can be used as sensor device for human

recognition from their gait after applying the required processing circuits with self learning capacities.

## REFERENCE

- [1] Xiong H. *Piezoelectric Energy Harvesting for Public Roadways*. PhD dissertation thesis in Civil Engineering, Virginia Polytechnic Institute and State University, December 2014.
- [2] Kim S., J. Shen, M. Ahad. *Piezoelectric-Based Energy Harvesting Technology for Roadway Sustainability*. International Journal of Applied Science and Technology, Vol. 5, No. 1, February 2015, ISSN 2221-0997.
- [3] Wang H., A. Jasim, X. Chen. *Energy harvesting technologies in roadway and bridge for different applications – A comprehensive review*. Applied Energy, Vol. 212 (2018), pp. 1083–1094, ISSN: 0306-2619.
- [4] Yang C.-H. and team. *Feasibility study of impact-based piezoelectric road energy harvester for wireless sensor networks in smart highways*. Sensors and Actuators A, Vol. 261 (2017), pp. 317–324, ISSN: 0924-4247.
- [5] Comet Electronics – Е-Магазин, каталог: <https://store.comet.bg/CatalogueFarnell/Product/178687/>